

Cross Ref: \_\_\_\_\_  
 (Office Use Only)

Unit 10 & 11 · Princes End Ind Park · Nicholls Rd · Tipton · DY4 9LG

## Wooden Trim Questionnaire

E: marcus@mdwoodtech.co.uk

Date: \_\_\_\_\_

W: www.mdwoodtech.co.uk

T: 01902 493930

F: 01902 493362

### Customer Details (Please Enter Details)

Company (if applicable):		Contact Name:	
Address:			
Postcode:		Boat Name (if applicable):	

Telephone:		Mobile:	
Email Address:			

### Wood Options (Please Tick)

Ash	<input type="checkbox"/>	Oak	<input type="checkbox"/>	Steamed Beech	<input type="checkbox"/>
Sapele	<input type="checkbox"/>	Idigbo	<input type="checkbox"/>	Cherry	<input type="checkbox"/>
Other (Please Specify)... _____					
Spray Applied / Acid Catalyst Lacquer to all items? _____					

### Shape Options (Please Tick & Complete Specification Details)

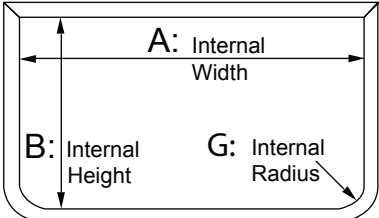
1.  

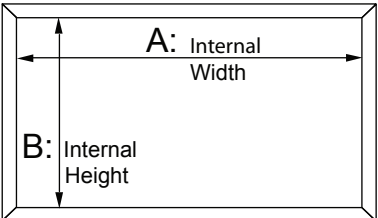
2.  

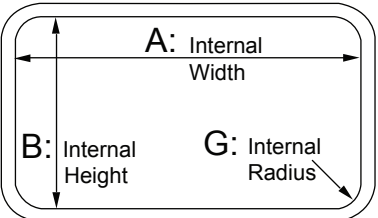
3.  

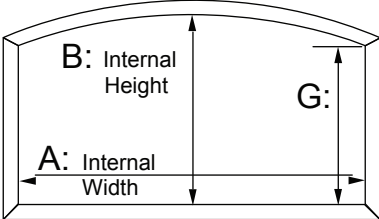
4.  

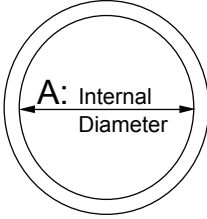
5.  

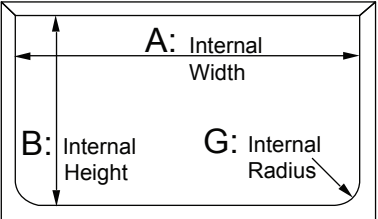
6.  

7. Special (Please provide drawing and/or template).....

C = Depth E = 12mm Std  
 D = Flange F = 12mm Std

#### Specification Details

Item	Qty	Shape No.:	Dim A:	Dim B:	Dim C:	Dim D:	Dim E:	Dim F:	Dim G:
A									
B									
C									
D									
E									
F									

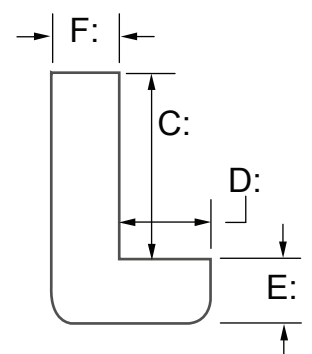

**IMPORTANT NOTE: ITEMS WILL BE MADE TO EXACT MEASUREMENTS - PLEASE MAKE CLEARANCE ALLOWANCES WHERE NECESSARY.**